

REVISIONS				
SYM.	ZONE	DESCRIPTION	DATE	APPROVAL
-			-	-

26 HD MALE, #K86-AA-26P, (ECK01259)
BACKSHELL, #17-1725-2, (ECK01022)

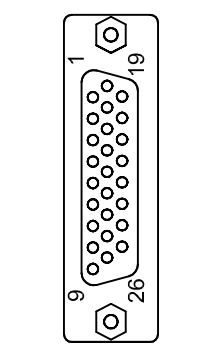

VIEW FROM SOLDER SIDE

TO ENSEMBLEHPE #1
J205 AUX IO
(PORT 0)

TO ENSEMBLEHPE #2
IO BOARD

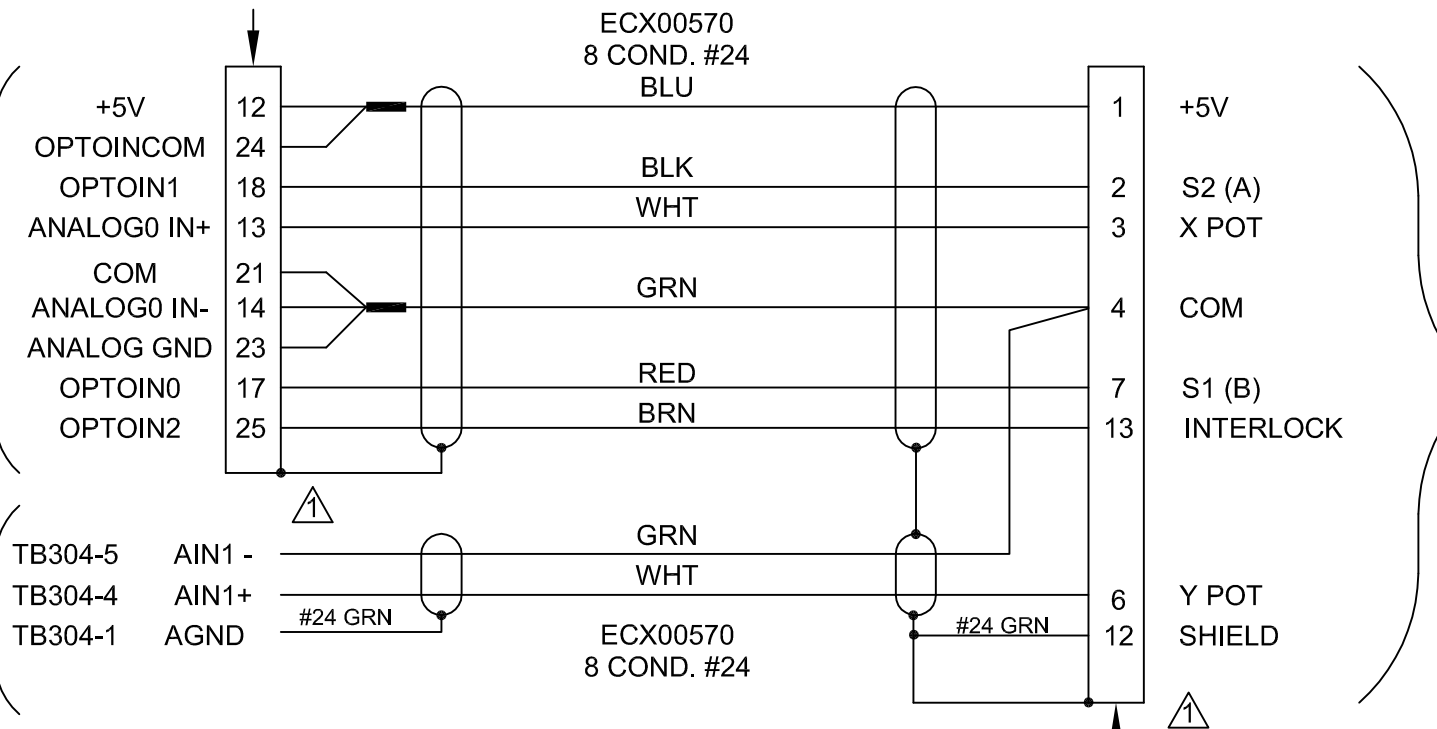

CONNECTOR SHIELDING

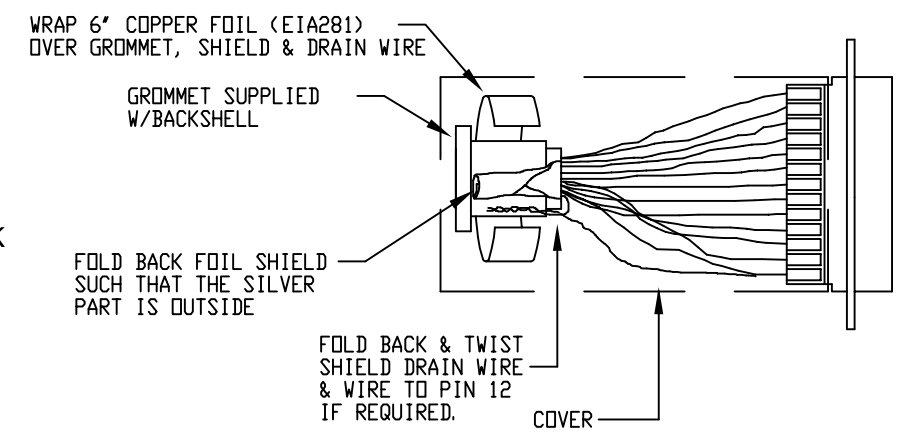

WIRE MARKERS

LABEL WIRES WITH BRADY LABELS AS NOTED
PSPT-125-175-WT WIRE MARKING SLEEVE #22-16 GA (EIA01161)

CABLE LENGTH

CAUTION, CABLE LENGTHS (XX) ARE IN DECIMETERS
EXAMPLE: C22779-30
30 = 30 DECIMETERS (3 METERS) = 10FT.

BACKSHELL, #17-1725-2, (ECK01022)
JACKSOCKETS, #207719-3, (ECK00129)
15 LINE FEMALE "D"
DA-15S, ECK00326

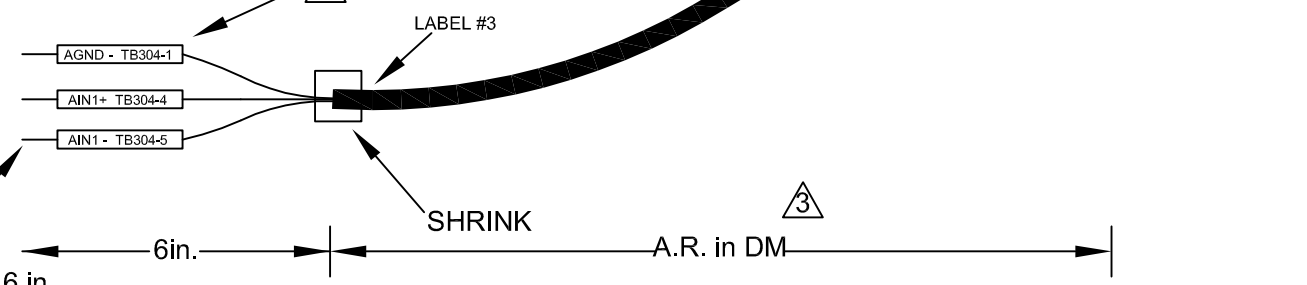

LABEL #1 FOR C22779 CABLES: (1) REQUIRED

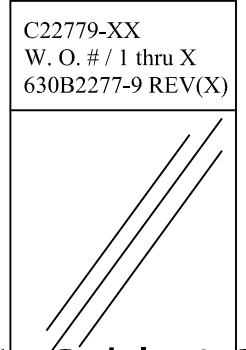

LABEL #2 FOR C22779 CABLES: (1) REQUIRED

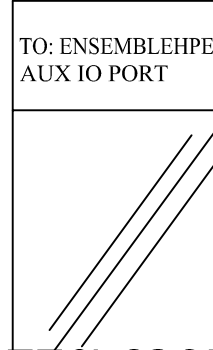

LABEL #3 FOR C22779 CABLES: (1) REQUIRED

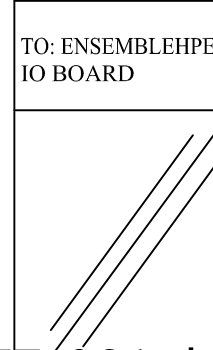

PROPRIETARY INFORMATION
THIS DRAWING IS THE PROPERTY OF AEROTECH, INC. AND IS SUBMITTED IN CONFIDENCE AND SHALL NOT BE REPRODUCED NOR COPIED NOR DISCLOSED TO OTHERS UNDER PENALTY OF LAW.



AEROTECH, INC. 101 Zeta Drive
Pittsburgh, PA. 15238
www.aerotech.com

ENSEMBLEHPE DUAL AXIS JOYSTICK CABLE

(JSXT-FLY 26HD-15DU-MAX 300 DM)

TOLERANCES ON		
FRACTIONS	DECIMALS	ANGLES
0 TO 6 ±1/32	.XX ±01	± 0-30'
OVER 6 ±1/16	.XXX ±005	
RMS FINISH	EXCEPT AS NOTED	

DRAWN	TES	9/1/09	PART CODE	SIZE	REV.
CHECKED	EJB	9/1/09	C22779-XX	B	-
			630B2277-9		