

REVISIONS				
SYM.	ZONE	DESCRIPTION	DATE	APPROVAL
-			-	-

26 HD MALE, #K86-AA-26P, (ECK01259)
BACKSHELL, #17-1725-2, (ECK01022)

ECX00570
8 COND. #24
BLU

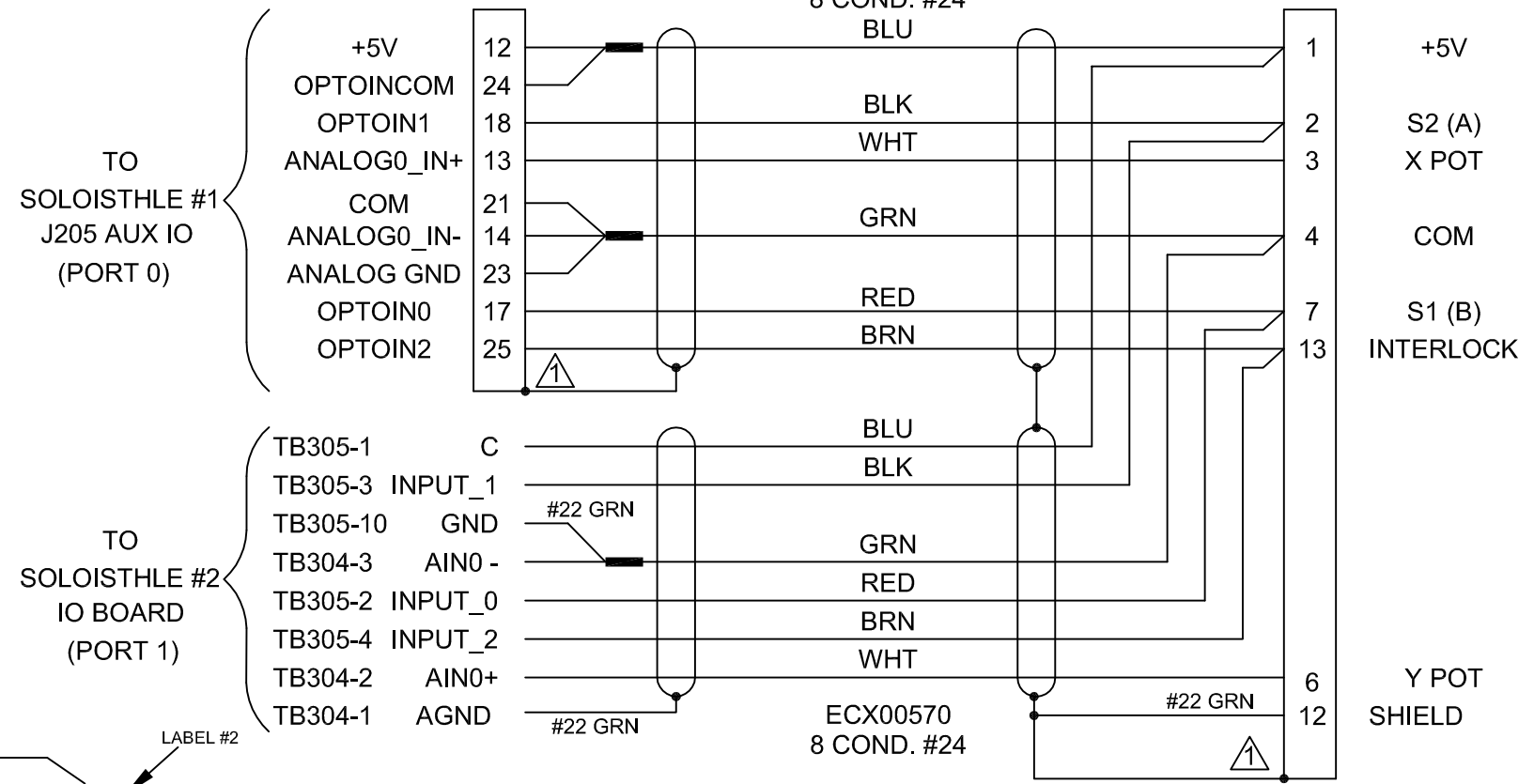

TO JOYSTICK

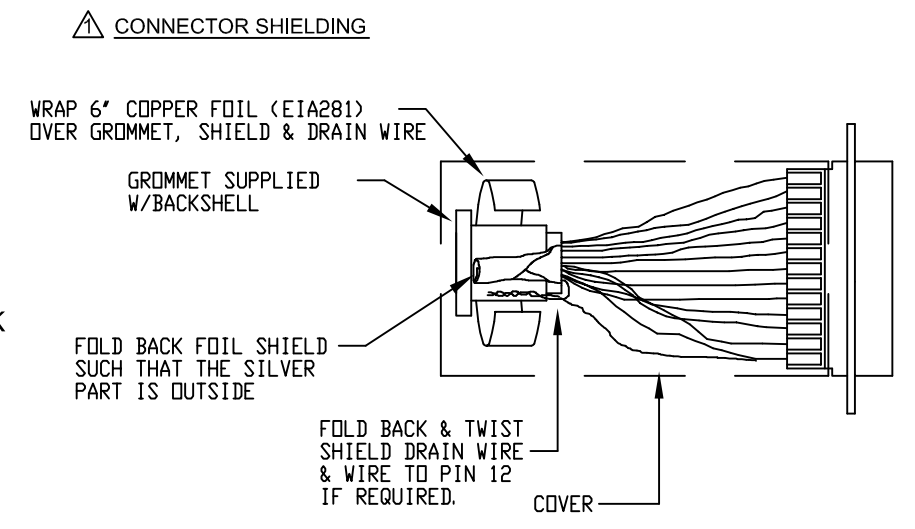

WIRE MARKERS
LABEL WIRES WITH BRADY LABELS AS NOTED
PSPT-125-175-WT WIRE MARKING SLEEVE #22-16 GA (EIA01161)

CABLE LENGTH
CAUTION, CABLE LENGTHS (XX) ARE IN DECIMETERS
EXAMPLE: C227612-30
30 = 30 DECIMETERS (3 METERS) = 10FT.

BACKSHELL, #17-1725-2, (ECK01022)
JACKSOCKETS, #207719-3, (ECK00129)
15 LINE FEMALE "D"
DA-15S, ECK00326

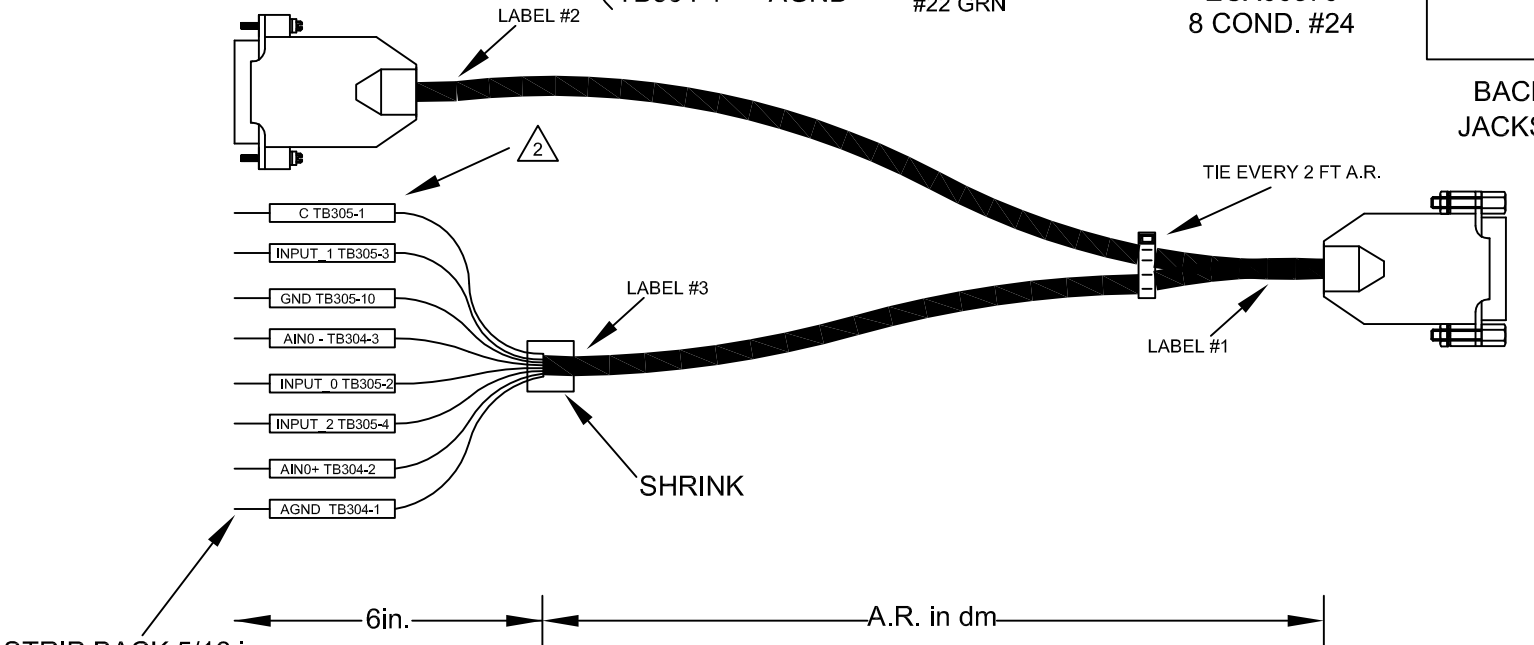
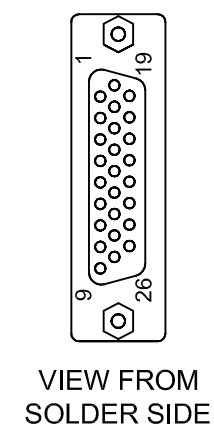

STRIP BACK 5/16 in.
3 PLCS

LABEL #1 FOR
C227612 CABLES:
(1) REQUIRED

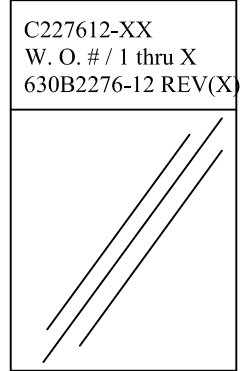

CABLE WRAP LABEL: EIA00113

LABEL #2 FOR
C227612 CABLES:
(1) REQUIRED

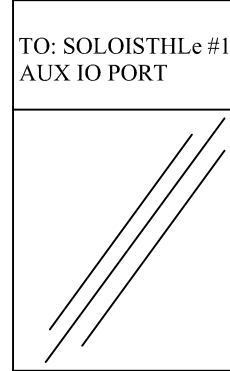

CABLE WRAP LABEL: EIA00113

LABEL #3 FOR
C227612 CABLES:
(1) REQUIRED

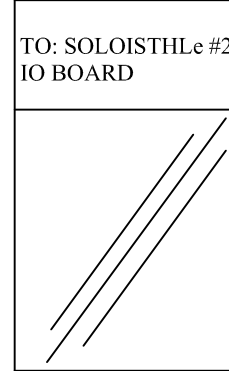

CABLE WRAP LABEL: EIA00113

PROPRIETARY INFORMATION
THIS DRAWING IS THE PROPERTY
OF AEROTECH, INC. AND IS
SUBMITTED IN CONFIDENCE AND
SHALL NOT BE REPRODUCED NOR
COPIED NOR DISCLOSED TO OTHERS
UNDER PENALTY OF LAW.



AEROTECH, INC. 101 Zeta Drive
Pittsburgh, PA. 15238
www.aerotech.com

SOLOISTHLE DUAL AXIS JOYSTICK CABLE (JSXT-FLY 26HD-15DU-MAX 300 DM)

TOLERANCES ON		
FRACTIONS	DECIMALS	ANGLES
0 TO 6 ±1/32	.XX ±01	± 0-30'
OVER 6 ±1/16	.XXX ±005	
RMS FINISH	EXCEPT AS NOTED	

DRAWN	TES	9/1/09	PART CODE	SIZE	REV.
CHECKED	EJB	9/1/09	C227612-XX	B	-
APPD.	AGS	9/1/09	SCALE NTS	FILE NAME	SHEET
				630B2276-1201.DWG	1 of 1

630B2276-12