

REVISIONS			
REV.	DESCRIPTION	DATE	DRAWN

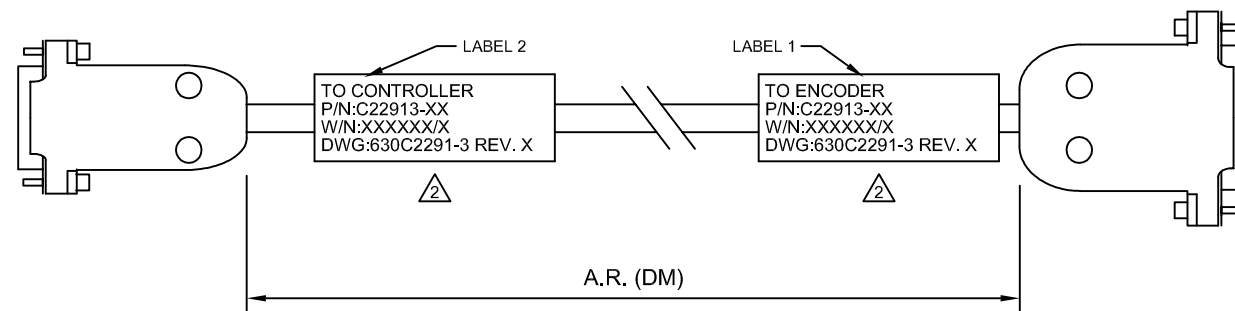
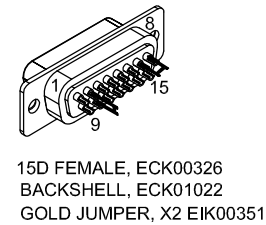
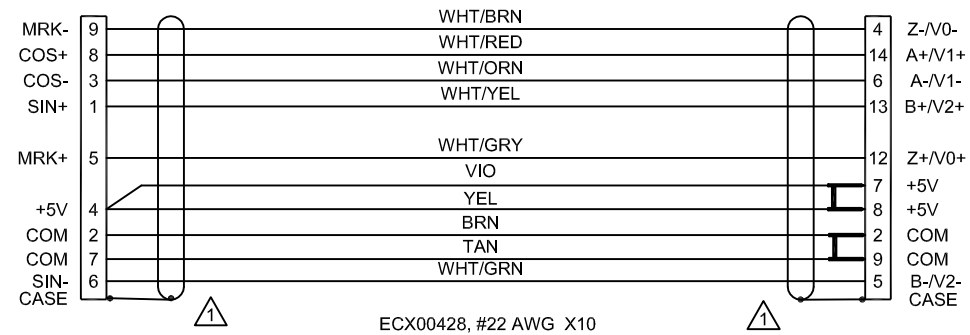
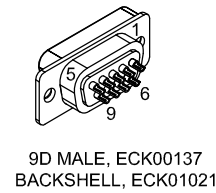

2 LABELS
LABEL PER VIEW BELOW

LABELS:
2 REQUIRED,
(1 AT EACH END)

SEE LABEL 2 ONLY
FOR DESTINATION

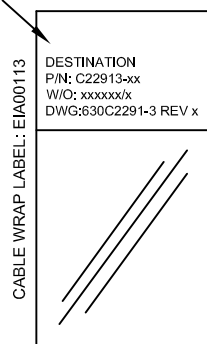

1 SHIELD TERMINATION

WRAP 3" COPPER FOIL, EIA00281
OVER GROMMET & SHIELD

USE APPROPRIATE GROMMET
SUPPLIED W/BACKSHELL

FOLD BACK FOIL
SHIELD, SO SILVER
SIDE IS OUTSIDE

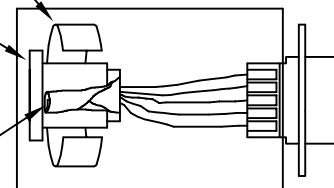

3 REQUIRED ENCODER ORIENTATION

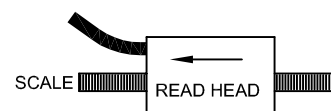

NOTE:
THIS DRAWING IS APPLICABLE WHEN CW
TRAVEL PRODUCES SCALE OR ENCODER
READHEAD MOTION AS SHOWN ABOVE
(PUSH ENCODER CABLE)

PROPRIETARY INFORMATION
THIS DRAWING IS THE PROPERTY
OF AEROTECH, INC. AND IS
SUBMITTED IN CONFIDENCE AND
SHALL NOT BE REPRODUCED NOR
COPIED NOR DISCLOSED TO OTHERS
UNDER PENALTY OF LAW.



AEROTECH, INC. 101 Zeta Drive
Pittsburgh, PA. 15238
(412)963-7470
www.aerotech.com

TOLERANCES ON
FRACTIONS DECIMALS ANGLES
0 TO 6 ±1/32 .XX ±01 ± 0-30°
OVER 6 ±1/16 .XXX ±005

RMS FINISH EXCEPT AS NOTED

DRAWN	JFM	1/17/18
CHECKED	JAB	1/17/18
APPD.	JFM	1/17/18

XR3/XR6 SECONDARY FEEDBACK CABLE ENC FB-9D-15D-TNCD-PSH-MAX116DM		PART CODE C22913	SIZE C	630C2291-3	REV. -
SCALE	NTS	FILE NAME	630C2291-3.dwg	SHEET	1 OF 1