

REVISIONS			
REV.	DESCRIPTION	DATE	DRAWN

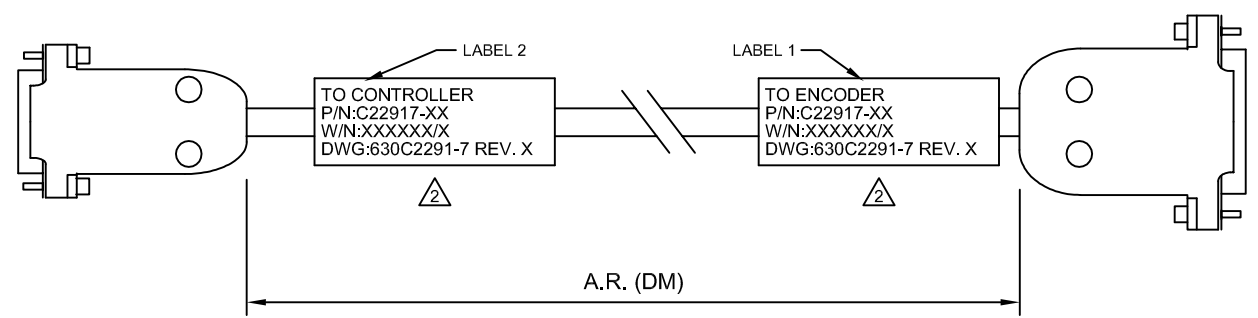
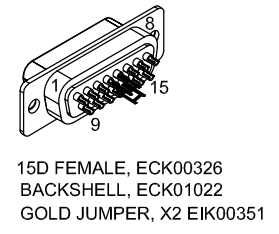
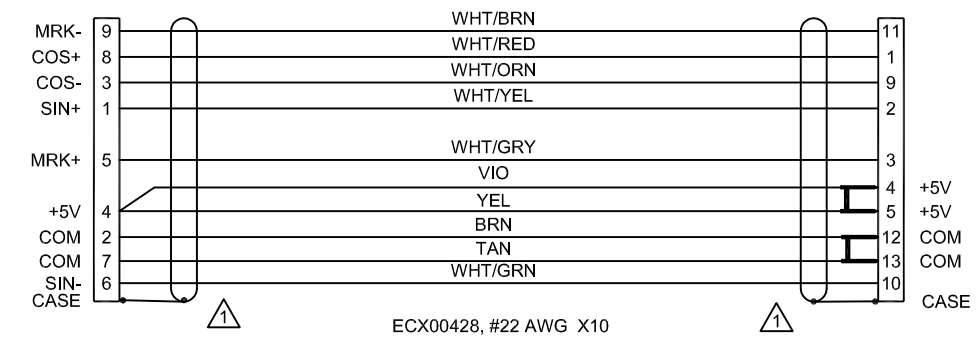
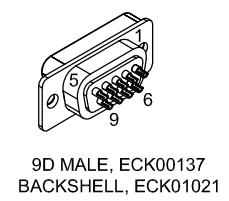

2 LABELS

LABEL PER VIEW BELOW

LABELS:
2 REQUIRED,
(1 AT EACH END)

SEE LABEL 2 ONLY
FOR DESTINATION

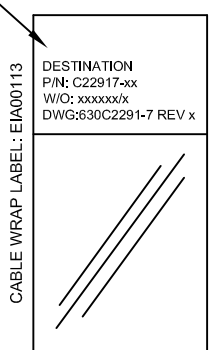

1 SHIELD TERMINATION

WRAP 3" COPPER FOIL, EIA00281
OVER GROMMET & SHIELD

USE APPROPRIATE GROMMET
SUPPLIED W/BACKSHELL

FOLD BACK FOIL
SHIELD, SO SILVER
SIDE IS OUTSIDE

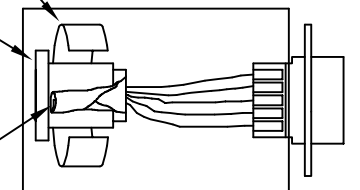

3 REQUIRED ENCODER ORIENTATION

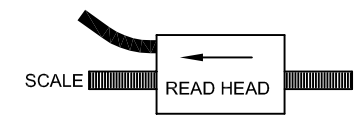

NOTE:
THIS DRAWING IS APPLICABLE WHEN CW
TRAVEL PRODUCES SCALE OR ENCODER
READHEAD MOTION AS SHOWN ABOVE
(PUSH ENCODER CABLE)

PROPRIETARY INFORMATION THIS DRAWING IS THE PROPERTY OF AEROTECH, INC. AND IS SUBMITTED IN CONFIDENCE AND SHALL NOT BE REPRODUCED NOR COPIED NOR DISCLOSED TO OTHERS UNDER PENALTY OF LAW.			AEROTECH, INC. 101 Zeta Drive Pittsburgh, PA. 15238 (412)963-7470 www.aerotech.com		
XR3/XR6 SECONDARY FEEDBACK CABLE					
ENC FB-9D-15D-TNCA-PSH-MAX116DM					
TOLERANCES ON FRACTIONS DECIMALS ANGLES 0 TO 6 ±1/32 .XX ±01 ± 0-30° OVER 6 ±1/16 .XXX ±005			RMS FINISH <input checked="" type="checkbox"/> EXCEPT AS NOTED		
DRAWN	JFM	1/17/18	PART CODE	SIZE	REV.
CHECKED	EJB	1/17/18	C22917	C	630C2291-7
APPD.	JFM	1/17/18	SCALE NTS	FILE NAME	630C2291-7.dwg
			SHEET	1 OF 1	