

REVISIONS			
REV.	DESCRIPTION	DRAWN	DATE
-	-	-	-

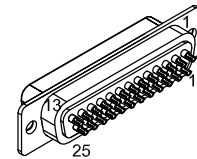

25 PIN MALE D-STYLE, ECK00101
BACKSHELL, ECK0656
ADD SCREW LOCKS

PIN	WIRE	SIGNAL
13	-	-
12	WHT/BRN	CW/+LMT
11	-	-
10	-	-
9	-	-
8	-	-
7	ORN	MKR
6	WHT/ORN	MKR-N
5	-	-
4	WHT/GRN	ID
3	VIO	ENC +5V
2	RED	ENC +5V
1	GRN	THERMISTOR
CASE	SHIELD/DRAIN	SHIELD
14	YEL	COS
15	WHT/YEL	COS-N
16	-	-
17	BLU	SIN
18	WHT/BLU	SIN-N
19	-	-
20	GRY	LMT COM
21	WHT	ENC COM
21	BRN	ENC COM
21	BLK	ENC COM
22	-	-
23	-	-
24	WHT/GRY	CCW-LMT
25	-	-

SIGNAL	WIRE	PIN
-	-	13
-	-	12
ØA	JMP TO PIN 23	11
ØA RETURN	JMP TO PIN 22	10
-	-	9
-	-	8
CCW-LMT	WHT/GRY	7
LMT COM	GRY	6
ENC COM	WHT	5
ENC COM	BRN	5
ENC COM	BLK	5
MKR-N	WHT/ORN	4
SIN-N	WHT/BLU	3
COS-N	WHT/YEL	2
KEY	KEY	1
BOTH SHIELDS	BOTH SHIELDS	CASE
COS	YEL	14
SIN	BLU	15
MKR	ORN	16
ENC +5V	VIO	17
ENC +5V	RED	17
ID	WHT/GRN	18
CW/+LMT	WHT/BRN	19
THERMISTOR	GRN	20
-	-	21
ØA RETURN	#20 WHT	22
ØA	#20 BLK	23
-	-	24
-	-	25
N.C. AT THIS END	#20 GRN/YEL	N.C.

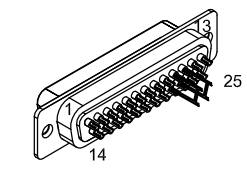

25 PIN FEMALE D-STYLE, ECK00300
BACKSHELL, ECK0656
JACK SOCKETS, ECK00129

ECX01009
16 COND, #24

UNUSED WIRES:
NONE

ECX01217
4 COND, #20

UNUSED WIRE:
RED

ADD GOLD JUMPER
EIK00351, 2 PLS.

4 PIN TERMINAL BLOCK W/COVER ECK01523
HOUSING, ECK01520

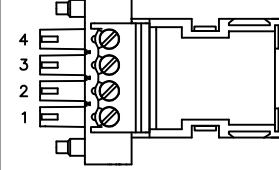

LABEL	WIRE	SIGNAL
4	#20 WHT	ØC
3	-	-
2	#20 BLK	ØA
1	#20 GRN/YEL	SHIELD/DRAIN

6 ADD THREE CABLE LABELS, EIA00113

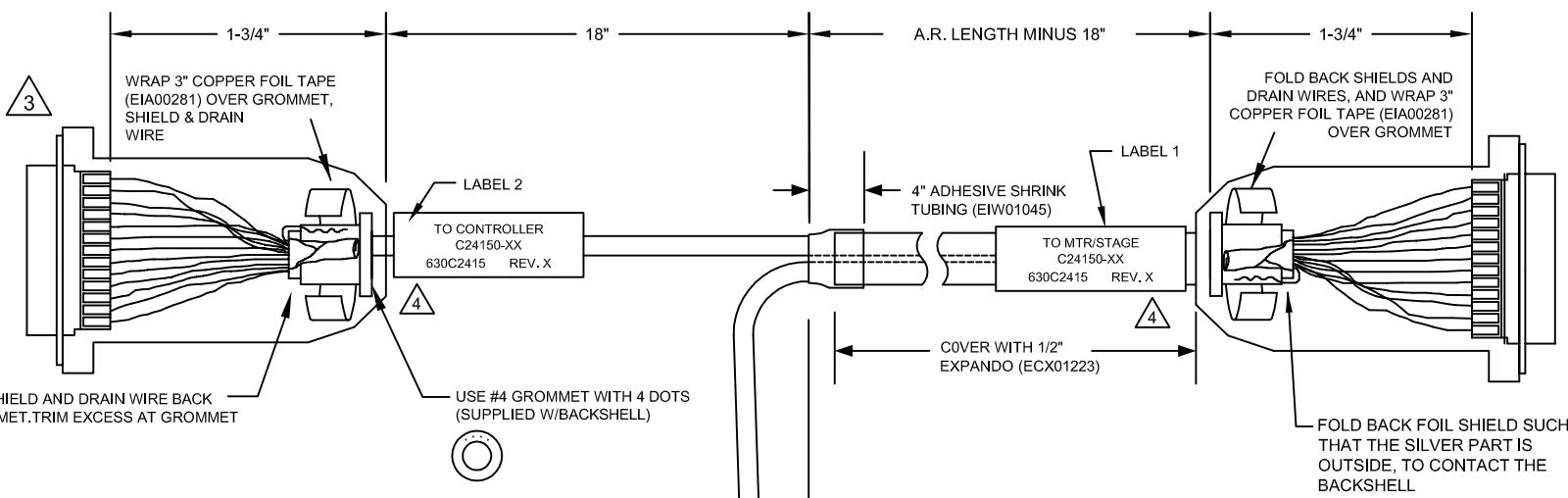
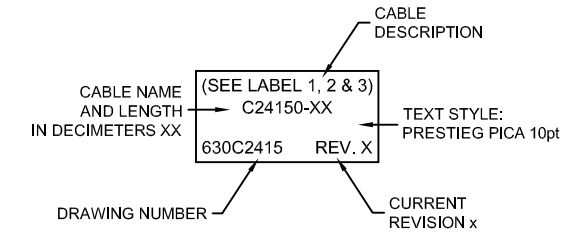

5 SPLICE 3 #24 WIRES TO 1 #22, SOLDER AND COVER WITH HEATSHRINK

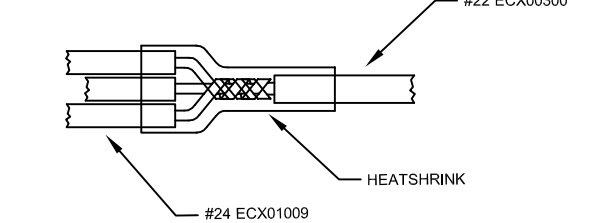

4 VERIFY GROMMET IS SECURED TIGHTLY AROUND CABLE. IF NECESSARY BUILD UP WITH SHRINK TUBING.

3 FOR CRIMP TOOL USE AMP HANDLE ASSY 58074-1 WITH AMP HEAD ASSY 58063-2

1 STARTING CABLE LENGTH SHOULD BE 5 IN LONGER THAN TOTAL LENGTH OF CABLE. LENGTH OF CABLE IS DESIGNATED BY THE (XX) IN CABLE NAME.

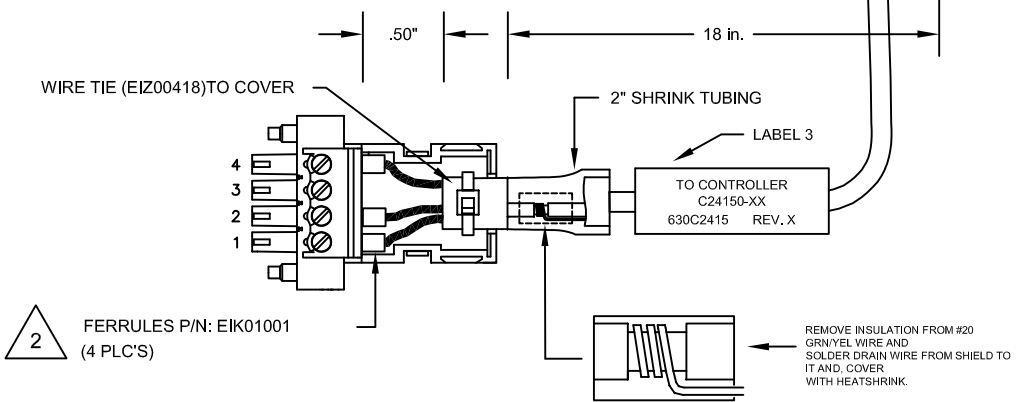

PROPRIETARY INFORMATION
THIS DRAWING IS THE PROPERTY OF AEROTECH, INC. AND IS SUBMITTED IN CONFIDENCE AND SHALL NOT BE REPRODUCED NOR COPIED NOR DISCLOSED TO OTHERS UNDER PENALTY OF LAW.

AEROTECH
AEROTECH, INC. 101 Zeta Drive
Pittsburgh, PA. 15238
(412)963-7470
www.aerotech.com

TOLERANCES ON		
FRACTIONS	DECIMALS	ANGLES
0 TO 6 ±1/32	.XX ±.01	± 0-30'
OVER 6 ±1/16	.XXX ±.005	

RMS FINISH ✓ EXCEPT AS NOTED

DRAWN	TES	7/9/13
CHECKED	JFM	7/9/13
APPD.	JFM	7/9/13

MPS SERIES DC STAGE TO Epaq FEEDBACK & MOTOR CABLE DC MTR & FB-4TS 25D-25D-5ARMS-MAX170DM			
PART CODE	SIZE	REV.	
C24150	C	630C2415	-
SCALE	NTS	FILE NAME	630C2415.Dwg
SHEET	1 OF 1		