

REVISIONS			
REV.	DESCRIPTION	DATE	DRAWN
A	ADDED ECO 69	5/25/2017	JFM

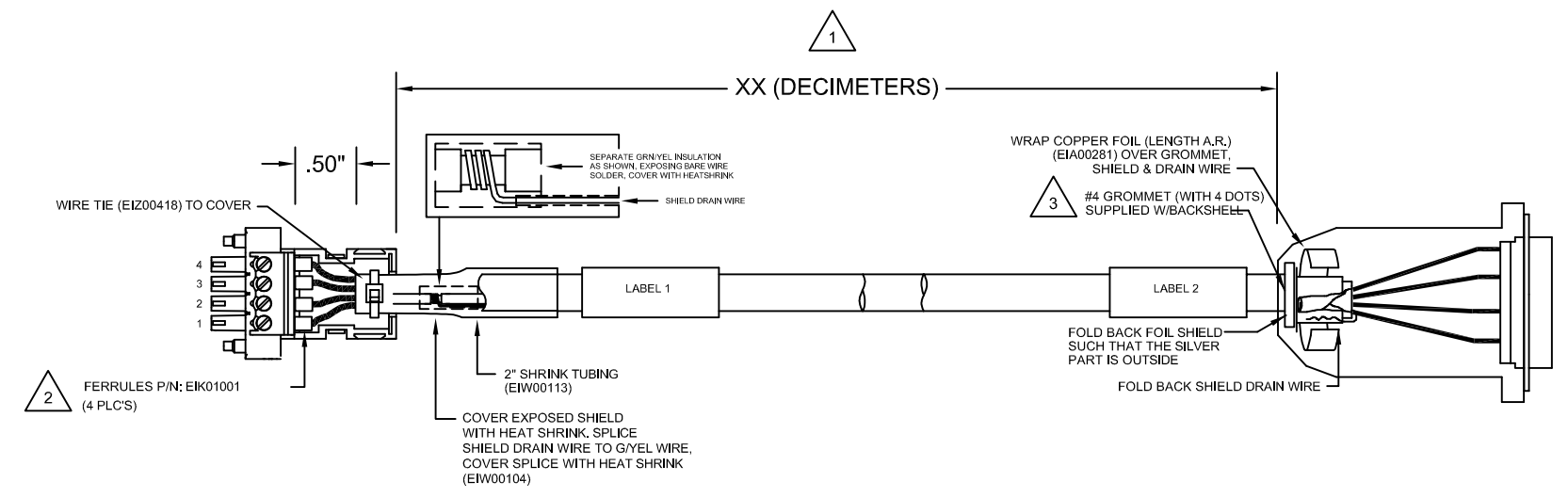
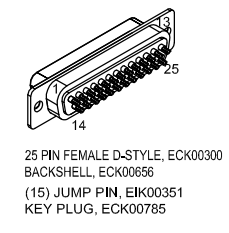
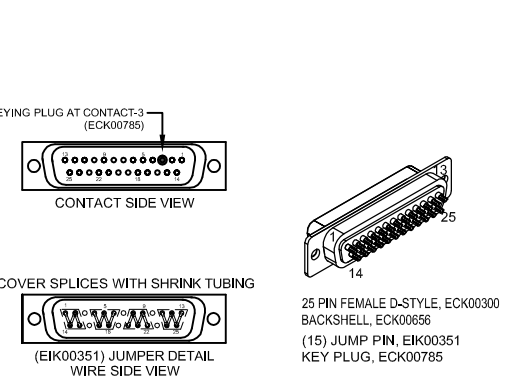
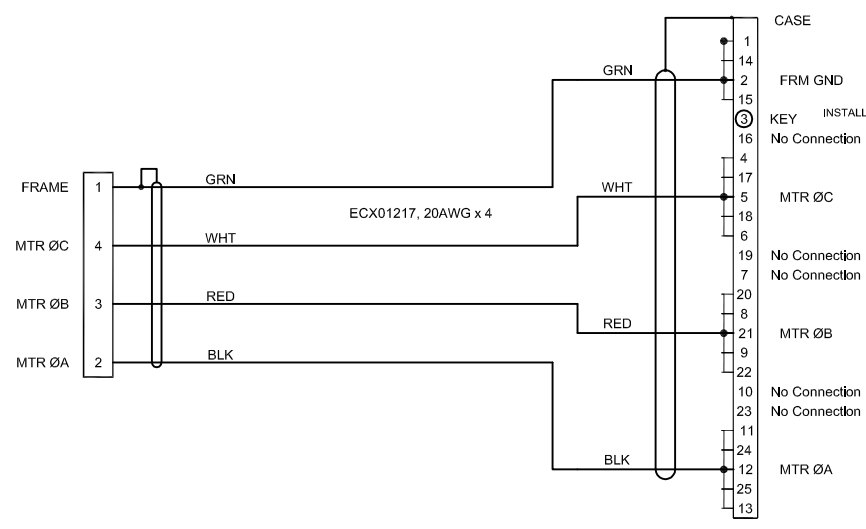
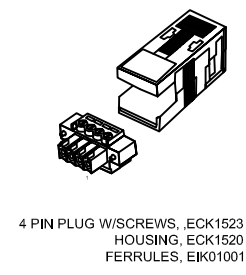

1 XX (DECIMETER) X .328 = FT.

2 STRIP INSULATION BACK 1/4" TO 5/16" ADD FERRULES P/N: EIK01001

3 USE #4 GROMMET WITH 4 DOTS AS SHOWN BELOW WHICH IS SUPPLIED W/BACKSHELL

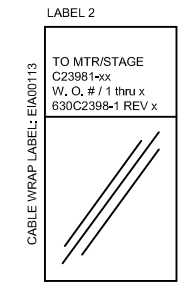
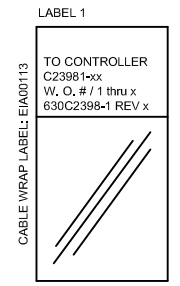

PROPRIETARY INFORMATION THIS DRAWING IS THE PROPERTY OF AEROTECH, INC. AND IS SUBMITTED IN CONFIDENCE AND SHALL NOT BE REPRODUCED NOR COPIED NOR DISCLOSED TO OTHERS UNDER PENALTY OF LAW.		
TOLERANCES ON FRACTIONS DECIMALS ANGLES 0 TO 6 ±1/32 .XX ±0.1 ° 0-30' OVER 6 ± 1/16 .XXX ±.005		
RMS FINISH	EXCEPT AS NOTED	
DRAWN	JLD	5/14/13
CHECKED	EJB	5/14/13
APPD.	EJB	5/14/13

AEROTECH AEROTECH, INC. 101 Zeta Drive
Pittsburgh, PA, 15238
(412)963-7470
www.aerotech.com

LOW POWER BRUSHLESS MOTOR CABLE

CABLE: BL MTR-4TS-25D-5ARMS-MAX450DM

PART CODE	SIZE	REV.
C23981	D	A